

The LCARA Patch

Volume 30, Issue 5

May 2008

The LCARA Patch

Published by the Lake County Amateur Radio Association
P O Box 868
Painesville, OH 44077-0868

The Patch Staff

Editor: Bob Mekinda, K8QXO

LCARA Officers

Rick Christian, N8BY, President
Bill Wihebrink, N8IJG, Vice-President.
Bob Mekinda, K8QXO, Secretary
Ted Huddle, W4CID, Treasurer
Neal Linder, KC8OMO, Director at Large

Correspondents

Jim Pyle AA8OY DX
Scott Farnham KO8O History
Mike Goffos WB8ZGH E-Comm
Matt Welch KB1LCS Radio Officer
Reno Tonsi WT8C Contest
Bill Wihebrink N8IJG Web Master LCARA
Lori Martin KD8HKA Fundraising Committee

INSIDE THIS ISSUE

LCARA 2008 Programs	1-2
Monthly Happenings	2
From the President	3
April Meeting Minutes	3-4
Backscatter	4-5
DX Alert	5-6
Ham Exams	6
Public Service Calendar	7
For Your Information	7
Fundraising Committee	7
Net Information	8
Dayton Hamvention Bus trip	9
Field Day – 2008	10
Hamfest Calendar	10
Radio Officer Report	10-11
LCARA/Ohio QSO Party Results	11-12
Station and Antenna Grounding	12-13
From Your Editor	13
LCARA Member Interview	14-16
Pictures From The April Meeting	16

LCARA 2008 MEETING PROGRAMS

The following programs to be held at the Red Cross Building in Painesville:

MAY 7 - QRP Presentation – Anthony Luscre K8ZT

The following programs are tentative scheduled for Veterans Park in Mentor:

JUNE 4 – Insurance Policies for Amateurs – Ray Fallen ND8L

JULY 2 - (Under Development)

AUGUST 6 - (Under Development)

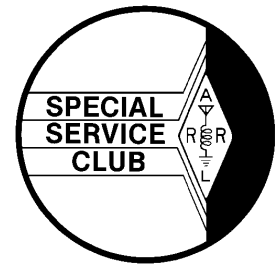

LCARA 2008 MEETING PROGRAMS (cont.)

The following programs are tentative scheduled for the Red Cross Building in Painesville:

SEPTEMBER 3 - Radio Astronomy – Hal Braschwitz W8PN

OCTOBER 1 - NWS Severe Weather in N.E. Ohio – Kirk Lombardy

NOVEMBER 5- Homebrew Night

DECEMBER 3 – Board Elections

Our **VP** has prepared a great series of programs so talk them up and invite your fellow amateurs to join us.

MONTHLY HAPPENINGS

“The Patch” – Please E-mail all articles to Bob Mekinda at lcaraeditor@lcara.org.

Club Breakfast is the 3rd Tuesday of the month at 8:30am at Perkins on Mentor Avenue in Painesville.

The LCARA club net is every Thursday at 19:00 on 147.210+ (PL 110.9). All are welcome.

The 10 Meter Net meets on Wednesday at 20:30 on 28.450 MHz. All are welcome.

The ARES® Net is every Monday at 19:30 on 147.210+ (PL 110.9). All are welcome.

The SKYWARN Net meets at 20:00 local on the 2nd & 4th Mondays of the month on 443.700+ (PL 131.8). All are welcome.

The LCARA membership meetings are held on the first Wednesday of the month at 7:30 pm in the:

Red Cross Building
1016 Bank Street
Painesville, OH 44077

Next meeting is May 7, 2008.



From the President:

Hello All, Here we are already in May. Where have the first four months gone? It is now time to put away the snow shovel and pull out that lawn mower. Fire up that BBQ and get started on those antenna projects. Remember we are getting into public service season so hopefully you will get out and lend a hand along with your fellow LCARA members. Hope to see you at the May meeting and please bring a friend. 73 and as always God Bless

Rick N8BY
President LCARA

MINUTES FOR April 2, 2008 MEETING

BOARD MEMBERS PRESENT:

Rick	N8BY	President
Bill	N8IJG	Vice-President
Ted	W4CID	Treasurer
Bob	K8QXO	Secretary

The meeting was called to order at 7:35 pm by Rick N8BY. Rick opened the meeting with a round of introductions of the members and guests present. He then turned the meeting over to Bill N8IJG to introduce the speaker, Jim Weaver K8JE, 8th Region Director, who made a presentation on the structure of the ARRL organization. He provided a comprehensive presentation of the ARRL organization and then opened the floor for all questions. After Jim's presentation a short break was taken prior to the start of the business meeting.

MINUTES: The March meeting minutes were accepted as published in the **PATCH**.

CORRESPONDENCE: None this month.

TREASURER: The Treasurer's report was presented by Ted W4CID without discussion and approved as submitted.

BOARD MEETING REPORT: Rick N8BY presented a synopsis of the March Board Meeting minutes and they were approved as presented. Next Board Meeting was to be held at Rick N8BY's home, but was shifted to Neal KC8OMO's home on April 17th at 7:00 PM.

NEW MEMBERS: James Mandelik KD8AKJ and Jim West W8SSZ

ARRL: Nothing to report this month.

DX [Jim AA8OY]: Provided updates on the activities currently taking place and scheduled for the month of April.

EDUCATION: Nothing to report.

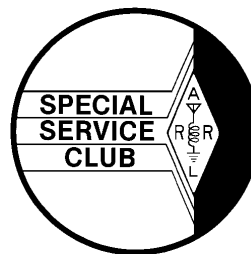

MINUTES FOR April 2, 2008 MEETING (Continued)

PUBLIC SERVICE: Mike WB8ZGH was unable to attend the meeting, however the following information was provided:

- 1.) The communications trailer has been delivered to the dealer.
- 2.) The Sunday in June Bike Ride will be the 2nd Sunday of June.

FIELD DAY: Currently in discussions with Holden Arboretum to confirm our use of Shadybrook for Field Day and will pass on the information as soon as received.

RADIO OFFICER [Matt KB1LCS]: Matt reported that the Diamond F23A 2-Meter antenna is working great as a transmit antenna. He is working to get the 4-bay VHF antenna down in warmer weather so it can be evaluated and put back in service. Matt is also going to check the controller as to why it's identifying after every minute.

SUNSHINE [Connie KB8ZZW]: Connie KB8ZZV and Reno WT8C provided an update on George N8GB and reminded us all that visitors are now welcome. He is recovering at Altercare which is next to St. Gabriel's Church on Rte. 84.

2 METER NET: The net is performing well each week.

10 METER NET: Paul W8PJW reported the Net is doing well. The Net begins at 8:30 pm on Wednesdays on 28.450 except the first Wednesday of the month which is the LCARA's club meeting night.

NEW BUSINESS: None to report.

FUNDRAISING COMMITTEE: Lori KD8HKA held the first Fundraising Committee meeting at her house in Willoughby on Monday March 24, 2008 at 7:00 pm. She is working on a presentation and still looking for additional members for the committee. Her address is available on QRZ or she can be emailed at KD8HKA@gmail.com..

Meeting Adjourned at 9:42 pm by Rick N8BY.

Respectfully Submitted,
Robert Mekinda K8QXO

BACKSCATTER

30 Years Ago: LCARA's 1st newsletter is published, the May 1978 issue. Members vote to add an autopatch line to the new repeater, WD8DQW/RPT on .81/21

Oops. Frequency coordination of the new repeater with the Ohio Area Repeater Council hits a snag. It may have to change frequencies!

Hams listed in the first rosters that are still in LCARA 30 years later are:

KB8OF, Jack Olpp	WD8IVL, Mike Valentino
K8BL, Bob Liddy	W2TS W2TTW, Joe Paquin
W8GQO, Dick Glenn	WB8ZGH, Mike Goffos



BACKSCATTER (cont)

25 Years Ago: The German DXpedition to the Spratley Islands is lost. After being fired upon as they approached the island, distress signals were heard from the 51' catamaran Siddhartha. Ships and planes are searching the area for wreckage.

Remember Tom Swifties? "Someone keeps kerchunking the machine", said Tom repeatedly.

20 Years Ago: Programs are introduced to the Lake County Hamfest. Videotape of the DXpedition to Navassa is shown (it's a small rock between Jamaica and Haiti). Jim Nestor, N8GJR, the computer columnist for the Plain Dealer hosts a SRO session on PC's in the shack. And on an ever-needed topic, Bob Winston, W2THU talks about hams and the law.

15 Years Ago: The FCC, having taken away 220-222 MHz, thinks about giving hams access to 219-220 MHz.

10 Years Ago: LCARA votes to spend \$6000 to upgrade the remote inputs and links on .81/.21 with 900MHz microwave equipment.

Mark Kundrath, KB8FKM wins his tower battle with Fairport. Since the Village's zoning laws and ordinances had no sections or parts relating to communications towers of any type, the zoning board concluded they must not be permitted. After six months and \$1000 of legal and engineering fees, Mark finally prevails.

5 Years Ago: Newsletter Editor Grant, N0XIL adds an Event Calendar to The Patch.

LCARA secretary Dennis, AB8NI rants in The Patch on club apathy.

May 2008 DX Alert

IRAN, EP. Hamid, EP4HR has been QRV on 17 meters around 1500 to 1600z, QSL via I2MQP.

SAINT BARTHELEMY, FJ. Juergen, FJ/DJ2VO will be QRV from April 19 to May 8. Activity will be on 40 to 10 meters, and possibly 80 meters, using CW, QSL to home call.

SAINT MARTIN, FS. John, K9EL will be QRV as FS/K9EL from April 24 to May 4 while on vacation. He will be active on 80 to 10 meters using mainly CW and SSB, and possibly RTTY, in his spare time, QSL to home call.

WESTERN SAHARA, S0. Mohamed, S01MZ has been active on 20 meters around 1700z, QSL via EA1BT.

TUVALU, T2. Udo, DL9HCU is QRV as T20HC. The length of his stay is unknown. He is generally active on 20 meters around 0500 to 0800z and 17 meters around 0800 to 1000z. QSL to home call

ALBANIA, ZA. Franck, ZA/F4DTO will be QRV from the city of Elbassan from April 22 to May 3. Activity will be on 20, 17 and 10 meters using SSB. QSL direct to home call.

UGANDA, 5X. Look for Mike, 5X1DX, mostly evenings and weekends, QSL PA7FM.

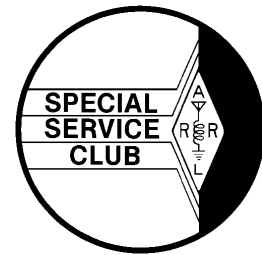

CHATHAM ISLANDS, ZL7. David will be operating as ZL7M on SSB May 10-11. QSL via VK2CZ.

Happy Hunting!
Jim Pyle, AA8OY
Thanks to ARRL DX & Weekly DX

If you are a LCARA club member and want to start a monthly column or have an article you would like to see in the next newsletter don't be shy. Contact Bob K8QXO and get it in print! All submissions have a deadline of the 18th day of the month.

HAM EXAMS IN LAKE COUNTY EVERY OTHER MONTH

The Lake County Amateur Radio Association will be holding its **2008** Amateur Radio license exams at the **Kirtland Library**, on the following dates:

Saturday, June 7
Saturday, August 2
Saturday, October 4
Saturday, December 6



This bi-monthly schedule is the first Saturday of every even-numbered month (e.g., February being the second month, etc.), and will be held at the Kirtland Library, 1.7 miles south of I-90 on Route 306. The library is on the left, immediately after the Marathon gas station.

To register, you will need the NCVEC 605 Form, which will be available at the test. If you would like to complete one ahead of time, you can find it at arrl.org/arrlvec/ncvec605.pdf. Please arrive by the following times:

Theory	12:00
Morse Code	1:00

Please bring **the original and a copy of both your license and any CSCEs you may have to the exam**. The cost is \$14.00, and if you wish to pay by check, it should be made out to the ARRL/VEC. Identification is also necessary, with a picture ID. If you have any questions, please contact Scott Farnham, KO8O, at (440)256-0320.

New Amateur Extra Class Question Pool Released:

The National Conference of Volunteer Examiner Coordinators (NCVEC) has released a new pool of 741 questions and 12 graphics <<http://www.ncvec.org/page.php?id=338>> for the Amateur Extra class license. This pool will become Effective for examinations given on or after July 1, 2008, and should be in service until June 30, 2012. It can be downloaded from the NCVEC Web site in Word, PDF or RTF formats. If you have any questions concerning the new Amateur Extra question pool, please contact the NCVEC's Question Pool Committee via e-mail <gpc@ncvec.org>.



PUBLIC SERVICE CALENDER 2008

(Note: Mark your Calendar for 2008 for the following events. Actual dates will be provided as soon as they are established).

June – Sunday in June Bike Ride
(Geauga Co.)

June 28-29TH – Field Day

July – Little Mountain Heritage Festival

August – Greater Cleveland Triathlon

September – IBIM Parade & Run

We are an active group, doing good things for the community, and having fun while doing it. Come and add your call to the 2008 events while building new friendships with other local hams.

Mike
WB8ZGH

For your Information

CLUB APPAREL

For those interested in purchasing club apparel with the club's logo and your name and call please go to <http://www.callsignwear.com/index.php> and pick out what you would like to order. Placing the order through the club will eliminate shipping charges. If you order direct you will incur shipping expenses unless you are placing a large order.

Tuesday Morning Breakfast Group

Next meeting of the group is at the Painesville Perkins on May 15th at 8:30. The date for June is the 15th. Keep these days open and join the group.

Fundraising Committee

Hello, this is Lori Martin, KD8HKA, and I am the Board-appointed Chairperson for LCARA's newly created Fundraising Committee. This committee's goal will be to research legal, compliant, and viable (as well as hopefully fun) ways of generating funds for the club, and then organizing and carrying out those fundraising events. I have researched a great number of other clubs around the country and have received from them some good fundraising ideas and suggestions. I also have a few ideas of my own, as well as others suggested by some of our own club members. All of these ideas were discussed at the first Fundraising Committee meeting which took place March 24, 2008 at my home. We are still looking for additional members and more ideas so if you have some of your own that you would like to share and are also willing to help see them come to reality, we would love to have you join the committee. If you are interested please contact me as soon as possible at (440) 527-8088, (440) 749-3937 or at KD8HKA@yahoo.com



NET INFORMATION

ARES®/SKYWARN NETS

They Lake County ARES® Net currently meets on 147.210 every Monday of the month at 1930 Local (7:30 PM).

They Lake County SKYWARN Weather Net currently meet's on 443.700(+) PL131.8 the 2nd and 4th Monday of each month at 2000 Local (8:00 PM).

You do not have to be ARES® or SKYWARN members to participate in these nets. ALL ARE WELCOME. Please mark your calendars' for Mondays at 1930.

Matt KB1LCS

'ARES' is a registered trademark of the American Radio Relay League, Incorporated, and is used by permission.



10 METER NET

The 10 Meter Net is up and running come join your fellow hams on Wednesday's at 8:30 PM on 28.450 MHz. This is an informal roundtable where the group can chat about anything that come to mind and even correct some of the world's problems.

You don't need to be a LCARA member, just at least a Tech ticket and some 10 meter gear. Here is a good chance to meet old and maybe some new friends. We might even have a check in from out of the local area.

Come join us.

2 METER NET

The 2 Meter Club Net meets every Thursday at 7:00 PM on the club repeater frequency of 147.210+ (PL 110.9). All are welcome.

NET CONTROL OPERATORS

Today all our nets need Net Control Operators, people go on vacation, can not be home on at Net time and unfortunately get ill. We are going to pass around a sign up sheet, think about it and see if you can fit it in your schedule and serve once a month or once every two months. Thanks in advance for your help.

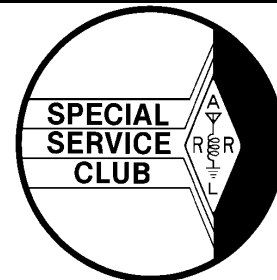

Pioneer Amateur Radio Fellowship, INC.

Dayton Hamvention 2008

Saturday May 17, 2008 5:30 AM

Are the gas pumps keeping you from the Hamvention? Is the thought of driving down to Dayton and then parking your car in some shopping center to be then bused to the hamvention keeping from going? Why not take our bus to the Dayton Hamvention where you can come and go to the flea market with your great purchases and leave them on the bus. The bus will be parked close to the flea market entrance.

You can save \$10 if you book before April 22nd

The cost of the Bus & Entrance ticket to the Hamvention:

\$60 before April 22, 2008

The cost of the Bus Only to the Hamvention:

\$45 after April 22, 2008

(You will need to get your own Hamvention Entrance Ticket at gate \$25)

We will take riders right up to departure that morning if there are seats available.

Departure time is 5:30 AM Sharp so please be on time so you don't miss the bus!

Parking will be on the south side of the church park in the first row close to Manchester Road.

There will be a stop for breakfast at McDonald's and a dinner stop at the Hometown Buffet all of which will be on own.

Transportation is being provided by the Crossroads Transportation Company.

This bus is a smoke free bus so there will be no smoking permitted.

To Order: Joy Spencer KA8TDF

2101 Bigelow St

Akron, OH 44314

Or call 330-745-5115

E-mail: w8ctt@arri.net



Field Day 2008

June 28-29, 2008

Mark your calendars now

Field day will be here before we know it. We hope you are planning on attending and operating this year. For those of you that have never experienced Field Day We hope that you will plan to take part this year. Watch for upcoming announcements.

Hamfest Calendar

16-18 May 2008 - Dayton Hamvention - Hara Arena - Dayton, OH - Dayton Amateur Radio Association -
Contact: PO Box 964 - Dayton, OH 45401 - Phone: 937-276-6930
<http://www.hamvention.org>

MAY Radio Officer's Report

I'd say things at the repeater site are going very well. The VHF machine sounds great since the transmit antenna had been replaced. Nice signal reports have been made from downtown Cleveland. But, the warmer weather has finally blessed us and I think it's about that time to have an antenna party at the repeater site. Take a look at your calendars. How much time could you spare? More information will be discussed at the May club meeting.

I went to the repeater site on Wednesday (04/23). I uploaded the newer version of the programming software to the computer and the firmware upgrade to the controller. It was a nice, easy, and smooth transition. From time to time, firmware upgrades are released from the manufacturer much like Microsoft except not every week.

After the software and firmware upgrades were complete, I shortened the hang time, the courtesy tone duration, and delay before courtesy tone on both repeaters. These items were draining on the overall timeout timer. I lessened the drain therefore increasing your talk time. The true test was the LCARA Thursday Night 2-Meter Net. Not one person timed out the machine.



Someone brought up an outstanding question. What are the components of our repeaters? I found the picture below on <http://www.repeater-builder.com>. This is a great representation of what we had before we separated the antennas. There is only one exception. We have two repeaters (one VHF, one UHF) connected to the same controller.

Radio Officer's Reported Submitted 04/26/08

73 de Matt KB1LCS

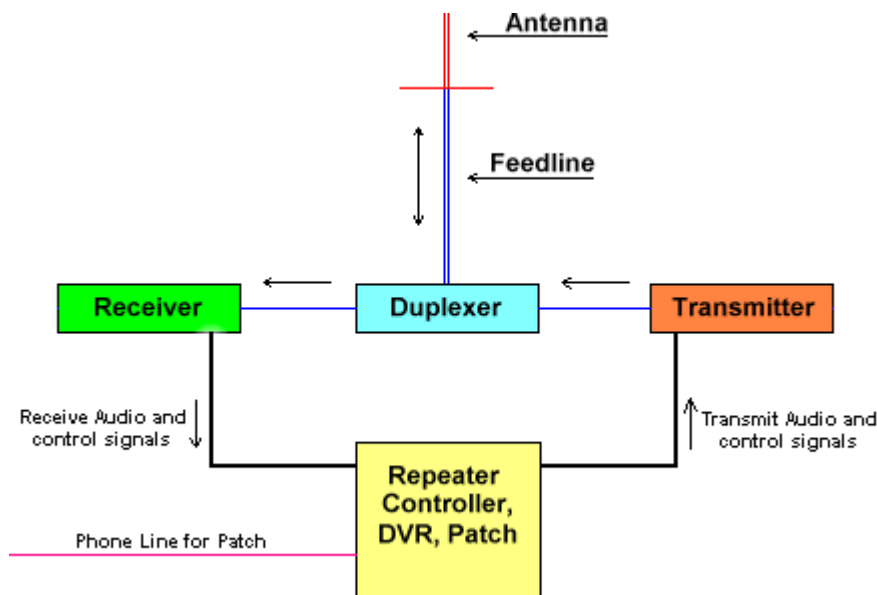

LCARA results in the 2007 OHIO QSO PARTY

The final results for the 2007 OQP have finally been tabulated and published. LCARA had (8) members submit scores.

In the club category, LCARA ended up in 4th position with a total score of 116,691 points. The winning club was the Medina 2 Meter Group with (6) members and a total score of 186,591 points.

In individual standings, members submitting scores were:

K8BL	42,745
WT8C	33,835
N8BY	17,138
N8BC	13,520 (K8BL was the operator and as I remember, this was because of a computer problem. Luckily, he was able to recover his K8BL log after the contest was over),



LCARA results in the 2007 OHIO QSO PARTY (cont.)

N8GB	7,125
KI8U	1,904
N8IJG	414
KB1LCS	10 (10 meters was just not open for Matt. Hopefully he will do better in 2008).

LCARA sponsors a plaque for the highest performing Mobile station. This year, the plaque was won by Jim Stahl, K8MR with a score of 81,589 points. Jim operated from 27 different counties to achieve this result.

The 2008 OQP will be held starting on August 23rd at 1600 UTC and will be over on August 25th at 0400. Lets try and get more club members active in this and see if we can win the Club plaque again.

For those interested in looking for more info on scores or the 2008 OQP, go to www.oqp.us.

73

Reno, WT8C

Station and Antenna Grounding

A lot of Hams route their antenna cables directly to their radios at their home QTH. This is not good practice when there is a chance of lightning strikes in their area. Even if there is not a direct strike, enough energy from a nearby strike could find its way to your equipment via your transmission lines or via the AC mains.

Solutions which avoid direct connection of antennas to radios include the use of antenna switches or patch panels. Choosing an antenna switch that grounds all unselected connections would be best. With this choice, you would always switch your radio off the antenna when not in use and place the switch in one of the grounded positions. I use an antenna patch panel that allows me to connect any radio to any antenna or dummy load.

My antenna patch panel has quick disconnect connectors at each end of the patch cables. I can totally remove all antenna connections quickly as needed. They don't get grounded as such, but I only use antennas that are at DC ground in the first place. My HF antennas all go through my Icom AT-500 Antenna Tuner, so there is still a complicated path before hitting my radios (756P3 or 775DSP) via IC-2KL.

Also, my radios are powered externally with an IC-PS30 or Astron RS-35M. So, spikes through the mains would also find a difficult path. Even so, these power supplies are fed through Isobar Power Line Filters which include surge suppressors.

Even so, as most of us know, dangerous spikes can often find their way to our sensitive equipment through the grounding path. Differing resistances between ground points can cause high differences in voltages when faced with the potentials involved with lightning. That is why station grounding is a primary concern to be dealt with.

You MUST create the most perfect earth ground you can muster OUTSIDE your station. Everyone's situation will be different, but it should include actual ground rods tied to a common point. You can include the metal pipes of your water system at the entry to your house - make sure the wiring is SHORTER than to your station. Also, make sure the ground at your mains entrance is equally as good at your service entry point (check with your power provider and

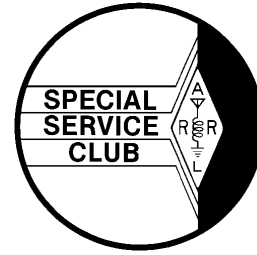

Station and Antenna Grounding

Electrician to be totally safe in these areas!).

Then, use the heaviest copper wire practical to bring your earth ground to your station. This run should be as short as possible. Any bends should be smooth turns with maximum radius - NO right angles. You must ONLY create ONE ground point. All equipment with a manufacturer's provided grounding lug will be connected individually to this ONE station ground point - NO DAISEY-CHAINING!! Use only copper wire of the same gauge. All ground wires MUST be of the SAME length and connect to the SAME point. This may seem like a lot of work/overkill, but it is well worth it from an equipment and personal safety standpoint.

Mount your single station ground point centrally behind your equipment. Get some green-insulated (green means ground) stranded 14 or 16 gauge copper wire and measure the longest length you'll need from an equipment ground lug to the station ground point. Then, make ALL the grounding wires you'll need this SAME length. Install spade lugs on each end of these jumper wires and connect them between the equipment ground lugs and the station ground point making sure the AC plug is physically removed from the mains during the wiring process.

Some last bits of advice. Whenever installing electrical equipment at your station, the first wire connected is always the ground and the last wire disconnected is always the ground - ALWAYS. (Ever notice that the ground prong on the 3-wire electrical plug is the longest? This wasn't designed by accident.) NEVER use the shield of coax as an equipment ground! NEVER add or remove the ground wire of equipment that is powered ON or plugged into the AC mains!

Be safe & have fun - in that order!

73/GL, Bob K8BL

FROM YOUR EDITOR

ONE FINAL NOTE

We would like to update the roster. We will have some update sheets at the meeting and we would like the following information to add to the database: Current E-Mail, Current Phone Number, Birthday (only month and day), Spouse's Name, Class of License, Are you a member of ARRL? Thank you in advance for your assistance in updating our records.

I continue to try to get new articles and expand our newsletter with each issue. Some of what I do may be good and some may not, however I need feedback for improvement. I am beginning to see other clubs newsletters and I hope in the next year to add a number of new features. So remember this is your newsletter and I want it to provide the information and updates on our hobby that you want to see. I want the **PATCH** to be a newsletter you look forward to receiving and reading every month.

Bob K8QXO
Secretary

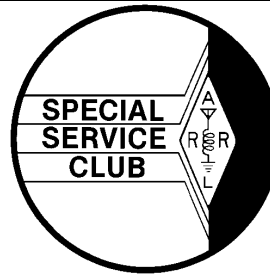

LCARA Member Interview: Doug Emerson (K8NFF)

[Finally we all know that we will soon be bidding Doug K8NFF a fond farewell as he departs for the sunny West Coast so I thought it was appropriate that I rerun his interview of October 2006 when he was our club President.]



You're Name: Doug Emerson

Any Nickname that you use? No

Your Call sign? K8NFF

What city do you live in? Painesville City

Have you ever had a different call sign and if so what was it? I have had several. KC8NFF, KC8HVG and back when I was first licensed in the 1960's, I had WN8TBH.

How did you become interested in Amateur Radio? When I was attending the Ohio School for the Blind, they had an open house to raise funds for the PTA. One year they had the Amateur Radio station set up in 1962 when I would have been a second grader. I saw the station and I was hooked. I wanted to get my license. The School required that you had to be a fifth grader to get your Amateur Radio License. Well, when I got into fifth grade the club had become inactive. But, when I became a sixth grader the school had hired a new industrial arts teacher. His name was Starling Hutt; his amateur radio call was W8QEM. He has since become a silent key. Shortly after he came, the word got around that he had a Ham Radio License. A group of us approached him and asked him if he would help us get our Ham Tickets because a number of us were interested.

He told us that he would go one better. He said that if we would get our Amateur Radio Licenses that he would give us an "A" in Industrial Arts for the whole year. Well that did it. About 17 of us got our Novice Tickets. So he had to give 17 of us students an "A" during the 1965-1966 school year. That's how I became interested in becoming an Amateur Radio Operator.

Do you have any other family members that are Hams? Yes, I do. I have an Uncle – I don't know if he is still living because I have lost touch with him. Don Teague is his name and he lives in California by the Oregon border and his Amateur Radio Call sign is or was W6AKI.

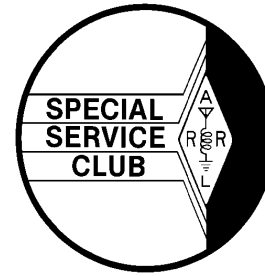

LCARA Member Interview (cont.):

How long have you been licensed and what class of license do you currently hold? Actually, I have been licensed twice. The first time in was 1966-1967 as a Novice, and then retook the test in 1997 and I received my Tech Plus. I became a General Class in 1999. That's what I currently hold today is a General Class license.

What do you like about Amateur Radio? I like all facets of it. I wish I could operate HF mostly but because of where I live and the setup here, it's not possible to erect an HF antenna. So, my operation is mostly relegated to our repeaters.

What are your favorite bands to work and why? I like to work 17 Meter phone because 17 Meters reminds me of how Amateur Radio should be. 17 Meters is what they call the Gentleman's band and the people on there act like gentlemen. Unfortunately, the other bands have kind of taken a turn for the worse. I also like to operate 20 Meter CW because of the propagation and it is a good band to work and most times of the year it is an easy band to work.

Do you collect QSL cards, if so do you have a favorite? No, I don't collect QSL cards. It's a little difficult for a blind person to do that because you have to go through the trouble of getting someone to help you fill out your QSL cards to send to others. So, if I get a QSL card from somebody, I usually answer it with a verification letter. I really should get some QSL cards but as far as collecting them, No I don't.

What types of awards or recognition have you ever won or been awarded? I have not won any awards. A couple of years ago I received a certificate from the Tri-County Traffic and Training Net for my participation as a new control station. I received an award 2 years ago for my participation in the Ohio QSO Party and I got a good commendation from the local Official Observer from our area for the way our 2 Meter Net was conducted.

What other hobbies do you have other than Ham Radio? All of my hobbies kind of intertwine with radio itself. I like sports like baseball and football and that revolves around radio because I listen to the radio because I can't get to the games. That's about it the only real hobby that I have is radio. I'm interested in all aspects of radio. Amateur radio, I'm a medium morning broadcast DXer, I'm a scanner enthusiast, so as I said, all of that revolves around radio.

What would your dream station be and where? If I could afford it, I would buy one of those big farms in either Ashtabula or Trumbull County where I could really setup an antenna farm. Something that has 50, 60, 80 acres and lets see as far as a station goes, If I could afford it, I always wanted a Collins "F" line.

Do you belong to any other Amateur Radio Groups? I am the Vice President of the Geauga Amateur Radio Association. I am also a member of The Chagrin Lagoons Amateur Radio Association as well as a Member of LCARA.

Do you check into Nets? If so, would you share the time and frequency: Yes I do, I am the net control station every other Sunday for the Tri-County Traffic and Training Net on the 147.015 repeater. I am also a regular check in with the Geauga Emergency Public Service Weather Net, Monday evenings at 9:00 PM on the 147.015 repeater and I also check in to the Chagrin Lagoons Amateur Radio Association Groups weekly gathering at 8:00 PM on the 443.700 repeater.

Have you ever participated in any radio special events or field day? If so, what did you like about it and what should we be doing more of? I have participated in Field Day on several occasions. Unfortunately that has been my only opportunity to operate HF. A year ago or so when our club had a special event station out at a park in Perry, I



LCARA Member Interview (cont.):

participated in that. When our club had the special event station promoting our participation with the Lake County Chapter of The Red Cross a few years ago, I participated in that too. I really like Field Day and hope to be able to continue operating at Field Day as long as I am able. I am hoping that our club might do more in the way of special event stations.

What types of speakers, subjects or presentations would you like to see us feature at the club meetings?

That's kind of a tough question. I'd say more things about the Amateur Radio Hobby. I know that Jim McAdams is going to do a program on DXpedition next month. I know that's going to be interesting. I would say that we should find someone who would be willing to come and share a few secrets about contesting because that seems to be a much closed part of the hobby. I also think we should try to find somebody that might be able to give an interesting elementary level talk about propagation. I think a lot of our club members who are Tech Plus or No Code Techs don't have a really good understanding about propagation. I think somebody needs to come and talk to us about that because different bands work differently at various times of the day and various times of the year.

What type of work do you do? How many years at your current job? If retired, what did you do?

I am retired. I used to be in the vending stand program operated by the Cleveland Society for the Blind. I worked there from 1974 until 1992. I lost my location; they closed it and so instead of continuing on, I decided to come back home. I missed my family even though I was in Cleveland. I wanted to be out here closer to my family, so I basically retired and came back home here to Painesville.

PICTURES FROM THE APRIL MEETING



LCARA was organized for the purpose of furthering Amateur Radio by increasing the technical knowledge and operating proficiency of radio amateurs through continuing education, public service and acting as a vehicle of communication by, between and with the members of the association. LCARA is an incorporated association chartered under the laws of the State of Ohio and is an exempt organization under section 501 (C) (3) of the Internal Revenue Code. Contributions to LCARA are fully deductible from Federal Income Tax. Regular and Senior Dues are \$20.00 per year, Students \$10.00. Items may be reprinted by other non-profit publications without prior permission providing credit is given to the original source and The LCARA Patch. Articles from members are welcome.

LCARA– The Lake County Amateur Radio Association

Regular LCARA meetings are open to all people interested in Amateur Radio, whether licensed or not! We meet at 7:30PM at the:

**Red Cross Building
1016 Bank Street
Painesville, OH 44077.**

Voice Repeaters N8BC

147.210 with a .600 Mhz+ offset PL tone of 110.9 Hz.
224.500 with a 1.6mhz.-offset, PL tone of 141.3 Hz.
444.650 With a 5.0 MHz. +offset, PL tone of 131.8 Hz.
(Repeater & N8BC trustee, Bob Liddy, K8BL)

Internet address: www.lcara.org

E-mail address: lcaraeditor@lcara.org

To receive the Patch via email in PDF format

Send an e- mail to lcara_patch-subscribe@yahoogroups.com